

Tepee Sofa

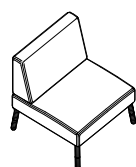

Without panel

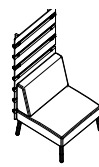

With panel

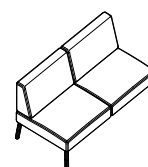

Without panel

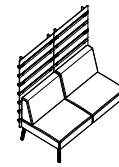

With panel

	Tepee 1-seater sofa S1	Tepee 2-seater sofa S2
	TEPEE SOFA S1	TEPEE SOFA S2
	• 1-seater sofa for integration or freestanding	• 2-seater sofa for integration or freestanding
	Basic price (EUR) according to upholstery price group	
2	1453	2387
3	1559	2786
4	1652	2974

Backrest finish					
BA-⑤	Upholstery		•		•
Seat finish					
SE-⑤	Upholstery		•		•
Leg finish					
BC-③/1.007	Powder-coated steel	Natural beech		•	•
BC-③/2.095		White stained beech		+28	+28
BC-③/2.07Y		Black stained beech			
Media 1					
	No media ports		•		•
⑦-YI001-⑧-B/B	PIX, power socket 230V	3000 mm cable length, black frame, black port		+105	+105
⑦-YI002-⑧-B/B	PIX, double USB charger socket			+153	+153
Media 2					
	No media ports		•		•
⑦-YI001-⑧-B/B	PIX, power socket 230V	3000 mm cable length, black frame, black port		—	+105
⑦-YI002-⑧-B/B	PIX, double USB charger socket				+153
Panel height					
	No panel		•	—	•
PH2	1586 mm height		—	+602	+1225
Integration					
	Module for integration		—	•	•
IN-F	Freestanding module		—	+63	+63
Panel finish					
DF-FC01/1.007	Grey felt	Natural beech		•	•
DF-FC02/1.007	Light grey felt			○	○
Sample order					
	TEPEE SOFA S1 (BA-CUZZQ SE-CUZZQ BC-WH/1.007)				
	TEPEE SOFA S1 (BA-CUZZQ SE-CUZZQ BC-WH/1.007 A-YI001-FR-B/B PH2 IN-F DF-FC01/1.007)				

③ – Please specify metal elements finish – [see finishes](#)⑤ – Please specify upholstery colour code from selected price group – [see finishes](#)⑦ – Please specify media port location – [see matrix](#)

⑧ – Please specify media port standard: CH13, FR, GB, GE

• Available as standard (included in basic price)

○ Available as an option (included in basic price)

Note: Connectors for connecting sofas with panels to be specified and calculated, [see price list](#).

Tepee Sofa

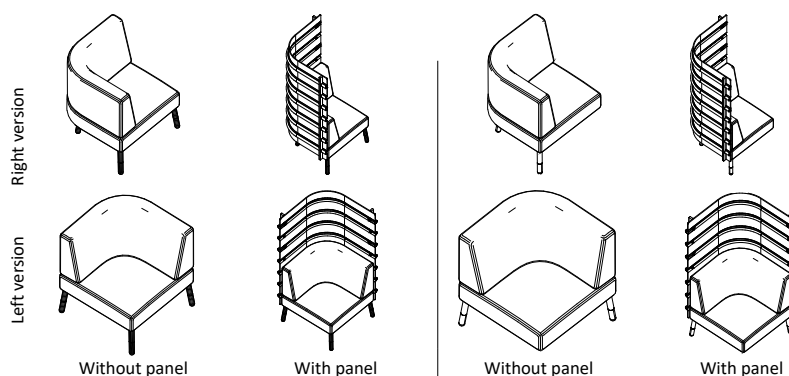

	Tepee 1-seater sofa C90	Tepee 1-seater sofa C90D
	TEPEE SOFA C90	TEPEE SOFA C90D
	<ul style="list-style-type: none"> • 1-seater corner sofa 90° • for one-sided integration or freestanding 	<ul style="list-style-type: none"> • 1-seater corner sofa 90° • for double-sided integration
	Basic price (EUR) according to upholstery price group	
2	1787	1787
3	1840	1840
4	1930	1930

		Version	
V-R	Right	•	•
V-L	Left	○	○
		Backrest finish	
BA-⑤	Upholstery	•	•
		Seat finish	
SE-⑤	Upholstery	•	•
		Leg finish	
BC-③/1.007	Powder-coated steel	Natural beech	•
BC-③/2.095		White stained beech	+28
BC-③/2.07Y		Black stained beech	
		Media	
	No media ports	•	•
⑦-YI001-⑧-B/B	PIX, power socket 230V	3000 mm cable length, black frame, black port	+105
⑦-YI002-⑧-B/B	PIX, double USB charger socket		+153
		Panel height	
	No panel	•	—
PH2	1586 mm height	—	+715

③ – Please specify metal elements finish – see finishes

⑤ – Please specify upholstery colour code from selected price group – see finishes

⑦ – Please specify media port location – see matrix

⑧ – Please specify media port standard: CH13, FR, GB, GE

• Available as standard (included in basic price)

○ Available as an option (included in basic price)

Note: Connectors for connecting sofas with panels to be specified and calculated, see price list.

PRICE GROUP 2: Cura, Xtreme

PRICE GROUP 3: Silvertex





PRICE GROUP 4: Blazer, Main Line Flax, skai Parotega, Synergy

Tepee Sofa

		TEPEE SOFA C90		TEPEE SOFA C90D	
Integration					
	Module for integration		●		●
IN-F	Freestanding module	—	+63	—	—
Panel finish					
DF-FC01/1.007	Grey felt	Natural beech	—	●	●
DF-FC02/1.007	Light grey felt		—	○	○
Sample order	TEPEE SOFA C90 (V-R BA-CUZ2Q SE-CUZ2Q BC-WH/1.007)				
	TEPEE SOFA C90 (V-R BA-CUZ2Q SE-CUZ2Q BC-WH/1.007 A-YI001-FR-B/B PH2 IN-F DF-FC01/1.007)				

- Available as standard (included in basic price)
- Available as an option (included in basic price)

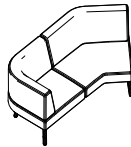
Tepee Sofa

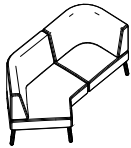
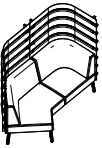
			Right version 	
	Without panel	With panel	Left version 	
	Tepee 1-seater sofa C135		Tepee 2-seater sofa C135+90	
	TEPEE SOFA C135		TEPEE SOFA C135+90	
	<ul style="list-style-type: none"> • 1-seater corner sofa 135° • for integration or freestanding 		<ul style="list-style-type: none"> • 2-seater corner sofa 135° + 90° • for one-sided integration or freestanding 	
	Basic price (EUR) according to upholstery price group			
2	1943		3200	
3	2367		4016	
4	2457		4202	

	Version			
V-R	Right		—	•
V-L	Left		—	○
	Backrest finish			
BA-⑤	Upholstery		•	•
	Seat finish			
SE-⑤	Upholstery		•	•
	Leg finish			
BC-③/1.007	Powder-coated steel	Natural beech	•	•
BC-③/2.095		White stained beech	+28	+35
BC-③/2.07Y		Black stained beech		
	Media 1			
	No media ports		•	•
⑦-YI001-⑧-B/B	PIX, power socket 230V	3000 mm cable length, black frame, black port	+105	+105
⑦-YI002-⑧-B/B	PIX, double USB charger socket		+153	+153
	Media 2			
	No media ports		•	•
⑦-YI001-⑧-B/B	PIX, power socket 230V	3000 mm cable length, black frame, black port	—	+105
⑦-YI002-⑧-B/B	PIX, double USB charger socket			+153
	Panel height			
	No panel		•	—
PH2	1586 mm height		—	+1265

③ – Please specify metal elements finish – see finishes

To complete sofa configuration select options on next pages →

⑤ – Please specify upholstery colour code from selected price group – see finishes

⑦ – Please specify media port location – see matrix

⑧ – Please specify media port standard: CH13, FR, GB, GE

• Available as standard (included in basic price)

○ Available as an option (included in basic price)

Note: Connectors for connecting sofas with panels to be specified and calculated, see price list.

PRICE GROUP 2: Cura, Xtreme

PRICE GROUP 3: Silvertex

PRICE GROUP 4: Blazer, Main Line Flax, skai Parotega, Synergy

Tepee Sofa

		TEPEE SOFA C135		TEPEE SOFA C135+90	
Integration					
	Module for integration		●		●
IN-F	Freestanding module	—	+63	—	+63
Panel finish					
DF-FC01/1.007	Grey felt	Natural beech	—	●	●
DF-FC02/1.007	Light grey felt		—	○	○
Sample order	TEPEE SOFA C135+90 (V-R BA-CUZ2Q SE-CUZ2Q BC-WH/1.007)				
	TEPEE SOFA C135+90 (V-R BA-CUZ2Q SE-CUZ2Q BC-WH/1.007 A-YI001-FR-B/B C-YI001-FR-B/B PH2 IN-F DF-FC01/1.007)				

- Available as standard (included in basic price)
- Available as an option (included in basic price)

Tepee Sofa

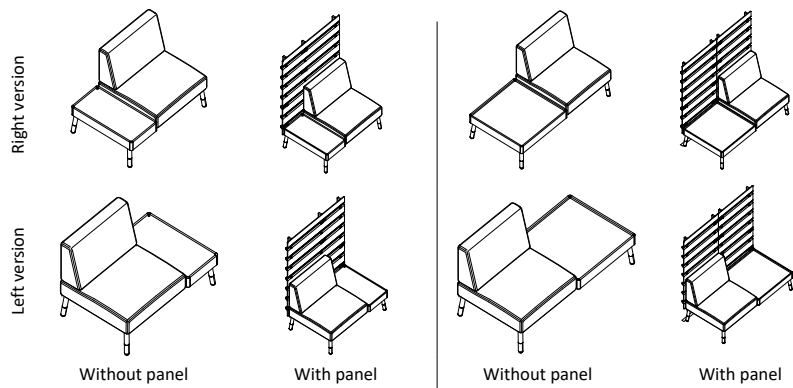

	Tepee 1-seater sofa STS	Tepee 1-seater sofa STB
	TEPEE SOFA STS	TEPEE SOFA STB
	<ul style="list-style-type: none"> 1-seater sofa with a small table for integration or freestanding table size 375 x 750 mm 	<ul style="list-style-type: none"> 1-seater sofa with a large table for integration or freestanding table size 750 x 750 mm
	Basic price (EUR) according to upholstery price group	
2	1885	1960
3	2053	2397
4	2146	2487

Version				
V-R	Right		•	•
V-L	Left		○	○
Backrest finish				
BA-⑤	Upholstery		•	•
Seat finish				
SE-⑤	Upholstery		•	•
Leg finish				
BC-③/1.007	Powder-coated steel	Natural beech	•	•
BC-③/2.095		White stained beech	+28	+28
BC-③/2.07Y		Black stained beech		
Media (sofa)				
	No media ports		•	•
⑦-Y1001-⑧-B/B	PIX, power socket 230V	3000 mm cable length, black frame, black port	+105	+105
⑦-Y1002-⑧-B/B	PIX, double USB charger socket		+153	+153
Panel height				
	No panel	•	—	•
PH2	1586 mm height	—	+899	—
Integration				
	Module for integration	—	•	•

③ – Please specify metal elements finish – see finishes

To complete sofa configuration select options on next pages →

⑤ – Please specify upholstery colour code from selected price group – see finishes

⑦ – Please specify media port location – see matrix

⑧ – Please specify media port standard: CH13, FR, GB, GE

• Available as standard (included in basic price)

○ Available as an option (included in basic price)

PRICE GROUP 2: Cura, Xtreme

PRICE GROUP 3: Silvertex

PRICE GROUP 4: Blazer, Main Line Flax, skai Parotega, Synergy

Tepee Sofa

			TEPEE SOFA STS		TEPEE SOFA STB	
Panel finish						
DF-FC01/1.007	Grey felt	Natural beech	—	•	—	•
DF-FC02/1.007	Light grey felt			○		○
Table top/edge finish						
TF-①/1.007	Laminate	Natural beech	•		•	
Media (table top)						
No media ports			•		•	
YB001-⑧-W/G	PLUTO, triple power socket 230V	1500 mm cable length, white frame, grey port	+ 532		+ 532	
YB003-⑧-W/G	PLUTO, double power socket 230V, double USB charger socket		+ 831		+ 831	
Sample order	TEPEE SOFA STS (V-R BA-CUZ2Q SE-CUZ2Q BC-WH/1.007 TF-DD/1.007)					
	TEPEE SOFA STS (V-R BA-CUZ2Q SE-CUZ2Q BC-WH/1.007 A-YI001-FR-B/B PH2 DF-FC01/1.007 TF-DD/1.007 YB001-FR-W/G)					

① – Please specify colour code for MFC, linoleum or laminate – [see finishes](#)

⑧ – Media port standard: CH13, FR, GB, GE

- Available as standard (included in basic price)

Note: Connectors for connecting sofas with panels to be specified and calculated, [see price list](#).

Tepee Sofa

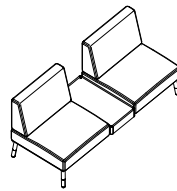

Without panel

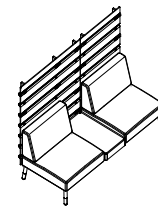

With panel

Tepee 2-seater sofa STC

TEPEE SOFA STC

- table size 375 x 750 mm

Basic price (EUR) according to upholstery price group

2	2791
3	3248
4	3434

	Backrest finish		
BA-⑤	Upholstery		•
	Seat finish		
SE-⑤	Upholstery		•
	Leg finish		
BC-③/1.007	Powder-coated steel	Natural beech	•
BC-③/2.095		White stained beech	+28
BC-③/2.07Y		Black stained beech	
	Media 1 (sofa)		
	No media ports		•
⑦-YI001-⑧-B/B	PIX, power socket 230V	3000 mm cable length, black frame, black port	+105
⑦-YI002-⑧-B/B	PIX, double USB charger socket		+153
	Media 2 (sofa)		
	No media ports		•
⑦-YI001-⑧-B/B	PIX, power socket 230V	3000 mm cable length, black frame, black port	+105
⑦-YI002-⑧-B/B	PIX, double USB charger socket		+153
	Panel height		
	No panel		• —
PH2	1586 mm height		— +1554
	Integration		
	Module for integration		•
IN-F	Freestanding module		— +63

③ – Please specify metal elements finish – see finishes

⑤ – Please specify upholstery colour code from selected price group – see finishes

⑦ – Please specify media port location – see matrix

⑧ – Please specify media port standard: CH13, FR, GB, GE

• Available as standard (included in basic price)

◦ Available as an option (included in basic price)

To complete sofa configuration select options on next pages →

Note: Connectors for connecting sofas with panels to be specified and calculated, see price list.

PRICE GROUP 2: Cura, Xtreme

PRICE GROUP 3: Silververtex

PRICE GROUP 4: Blazer, Main Line Flax, skai Parotega, Synergy

Tepee Sofa

TEPEE SOFA STC

Panel finish			
DF-FC01/1.007	Grey felt	Natural beech	—
DF-FC02/1.007	Light grey felt		•
Table top/edge finish			
TF-①/1.007	Laminate	Natural beech	•
Media (table top)			
No media ports		•	
YB001-⑧-W/G	PLUTO, triple power socket 230V	1500 mm cable length, white frame, grey port	+532
YB003-⑧-W/G	PLUTO, double power socket 230V, double USB charger socket		+831
Sample order	TEPEE SOFA STC (BA-CUZ2Q SE-CUZ2Q BC-WH/1.007 TF-DD/1.007)		
	TEPEE SOFA STC (BA-CUZ2Q SE-CUZ2Q BC-WH/1.007 A-YI001-FR-B/B C-YI001-FR-B/B PH2 IN-F DF-FC01/1.007 TF-DD/1.007 YB001-FR-W/G)		

① – Please specify colour code for MFC, linoleum or laminate – [see finishes](#)

⑧ – Media port standard: CH13, FR, GB, GE

• Available as standard (included in basic price)

○ Available as an option (included in basic price)

Note: Connectors for connecting sofas with panels to be specified and calculated, [see price list](#).

Tepee Sofa

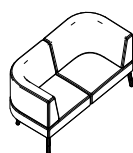

Without panel



With panel

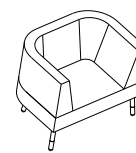

Without panel

	Tepee 2-seater sofa FS2	Tepee 1-seater sofa FS1
	TEPEE SOFA FS2	TEPEE SOFA FS1
	• 2-seater sofa, freestanding	• 1-seater sofa, freestanding
	Basic price (EUR) according to upholstery price group	
2	2897	2194
3	3258	2289
4	3444	2349

	Backrest finish			
BA-⑤	Upholstery		•	•
	Seat finish			
SE-⑤	Upholstery		•	•
	Leg finish			
BC-③/1.007	Powder-coated steel	Natural beech	•	•
BC-③/2.095		White stained beech	+ 28	+ 28
BC-③/2.07Y		Black stained beech		
	Media 1			
	No media ports		•	•
⑦-YI001-⑧-B/B	PIX, power socket 230V	3000 mm cable length, black frame, black port socket	+ 105	+ 105
⑦-YI002-⑧-B/B	PIX, double USB charger socket		+ 153	+ 153
	Media 2			
	No media ports		•	
⑦-YI001-⑧-B/B	PIX, power socket 230V	3000 mm cable length, black frame, black port socket	+ 105	—
⑦-YI002-⑧-B/B	PIX, double USB charger socket		+ 153	
	Panel height			
	No panel		•	•
PH2	1586 mm height		—	+ 1606
	Panel finish			
DF-FC01/1.007	Grey felt	Natural beech	—	•
DF-FC02/1.007	Light grey felt		—	○
Sample order	TEPEE SOFA F2 (BA-CUZ2Q SE-CUZ2Q BC-WH/1.007)			
	TEPEE SOFA F2 (BA-CUZ2Q SE-CUZ2Q BC-WH/1.007 A-YI001-FR-B/B C-YI001-FR-B/B PH2 DF-FC01/1.007)			

③ – Please specify metal elements finish – see finishes

⑤ – Please specify upholstery colour code from selected price group – see finishes

⑦ – Please specify media port location – see matrix

⑧ – Please specify media port standard: CH13, FR, GB, GE

• Available as standard (included in basic price)

○ Available as an option (included in basic price)

Note: Connectors for connecting sofas with panels to be specified and calculated, see price list.

PRICE GROUP 2: Cura, Xtreme

PRICE GROUP 3: Silvertex

PRICE GROUP 4: Blazer, Main Line Flax, skai Parotega, Synergy

Tepee sofa accessories – connectors



Tepee external sofa link ESL	Tepee internal sofa link ISL
CONNECTOR ESL	CONNECTOR ISL
<ul style="list-style-type: none"> Wooden external connector for connecting panel in sofa for integration 	<ul style="list-style-type: none"> Wooden internal connector for connecting panel in sofa for integration

	Number of pieces in a set	Basic price (EUR)	
J1	1 piece	—	33
J2	2 pieces	33	63
J4	4 pieces	63	—

Sample order	CONNECTOR ESL (J2)
--------------	--------------------

The number of internal connectors needed for assembly of Tepee sofas with panel:

$2 \times (n - 1)$ for sofas with panel height 1586,

n – the number of sofas / office panels in a specific arrangement.

Note: Number of connectors to be specified for each separate arrangement.

Connectors for freestanding sofas with panels and Tepee Walls included in assembly set.



Tepee sofa link SL
CONNECTOR SL
<ul style="list-style-type: none"> Metal connector for connecting sofas for integration 2 pieces in a set
Basic price (EUR)
15

Sample order	CONNECTOR SL
--------------	--------------

The number of internal connectors needed for assembly Tepee sofa:

$2 \times (n - 1 - k)$

n – the number of modules in a specific arrangement,

k – the sum of C90D modules in a specific arrangement.

Note: Number of connectors to be specified for each separate arrangement.

Tepee meeting table

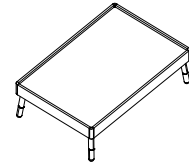
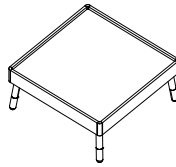

Tepee small table S	Tepee big table B
TEPEE TABLE S	TEPEE TABLE B
• Table size. D.750 x W.750 x H.350 mm	• Table size D:750 x W:1125 x H.350 mm
Basic price (EUR)	
1019	1162

		Table top/edge finish		
①/1.007	Laminate	Natural beech	•	•
		Media		
		No media ports	•	•
YB001-⑧-W/G	PLUTO, triple power socket 230V	1500 mm cable length, white frame, grey port socket	+ 532	+ 532
YB003-⑧-W/G	PLUTO, double power socket 230V, double USB charger socket		+ 831	+ 831
		Leg finish		
BC-③/1.007	Powder-coated steel	Natural beech	•	•
BC-③/2.09S		White stained beech	+ 28	+ 28
BC-③/2.07Y		Black stained beech		
Sample order	TEPEE TABLE S (BI/1.007 YB001-FR-W/G BC-WH/1.007)			

① – Please specify colour code for MFC, linoleum or laminate – see finishes

③ – Please specify metal elements finish – see finishes

⑧ – Please specify media port standard: CH13, FR, GB, GE

• Available as standard (included in basic price)

Note: Connectors for connecting sofas with panels to be specified and calculated, see **price list**.

Tepee office wall

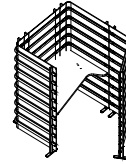

Tepee WORK sit

TEPEE WALL SI

- Workstation with a table top of height 780 mm

W••••	Width (mm)		1200
	Table top finish		Basic price (EUR)
TF-①	Melamine faced chipboard (MFC)		4242
	Media 1		
	No media ports/grommets		•
QB-③	Metal round grommet ø80 mm with brush		+28
YE004-⑧-SI/B	PIXEL, power socket 230V, double USB charger socket, 3000 mm cable length	Silver frame, black port	+415
YE004-⑧-SI/W		Silver frame, white port	
	Media 2		
	No media ports/grommets		•
QB-③	Metal round grommet ø80 mm with brush		
YE004-⑧-SI/B	PIXEL, power socket 230V, double USB charger socket, 3000 mm cable length	Silver frame, black port	+670
YE004-⑧-SI/W		Silver frame, white port	
	Panel height		
PH2	1586 mm height		•
	Integration		
	No integration (4 panels)	•	—
IN-IN	For integration (3 panels)	—	-688
	Panel foot		
PF-N-③	Narrow panel foot		•
PF-NW-③	Narrow internal panel foot, wide external panel foot	Powder-coated steel	+146 —
	Panel finish		
DF-FC01/1.007	Grey felt	Natural beech	•
DF-FC02/1.007	Light grey felt		○
Sample order	TEPEE WORK SI (W1200 TF-BI PH2 PF-NW-WH DF-FC01/1.007)		
	TEPEE WORK SI (W1200 TF-BI YE003-FR-SI/W PH2 PF-NW-WH DF-FC01/1.007)		

① – Please specify colour code for MFC, linoleum or laminate – [see finishes](#)

③ – Please specify metal elements finish – [see finishes](#)

⑧ – Please specify media port standard: CH13, FR, GB, GE

• Available as standard (included in basic price)

○ Available as an option (included in basic price)

Note: Connectors for connecting sofas with panels to be specified and calculated, see [price list](#).

Note: Integration of Tepee Work SIT workstation only possible with Tepee Walls. Linking connectors included in Tepee Wall assembly set.

Grommets and media ports position: Table top width 1200 mm – left and right

Tepee office wall

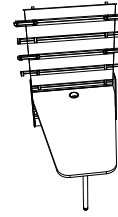

Tepee office wall TV

TEPEE WALL TV

- Straight office wall for integration, dedicated to connect with two sofas F2 with a panel

Basic price (EUR)

838

		Width		
W800	800 mm			•
		Panel height		
PH2	1586 mm			•
		TV holder		
	No TV holder			•
HO-TV	TV holder			+ 135
		Panel finish		
DF-FC01/1.007	Grey felt	Natural beech		•
DF-FC02/1.007	Light grey felt			○
		Table top finish		
TF-①	Melamine faced chipboard (MFC)			•
		Table leg finish		
BC-③	Powder-coated steel			•
		Media		
QC-W	Plastic square grommet with round outlet	White		•
QC-B		Black		○
YB001-⑧-W/G	PLUTO, triple power socket 230V	1500 mm cable length, white frame, grey port		+ 532
YB003-⑧-W/G	PLUTO, double power socket 230V, double USB charger socket			+ 831

Sample order	TEPEE WALL TV (W800 PH2 DF-FC01/1.007 TF-BI BC-WH)
	TEPEE WALL TV (W800 PH2 HO-TV DF-FC01/1.007 TF-BI BC-WH YB001-FR-W/G)

- ① – Please specify MFC colour code – see finishes
 ③ – Please specify metal elements finish – see finishes
 ⑧ – Please specify media port standard: CH13, FR, GB, GE
 • Available as standard (included in basic price)
 ○ Available as an option (included in basic price)

Note: Connectors included in Tepee Wall TV assembly set.

Tepee office wall

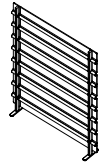
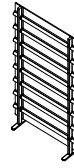

Tepee office wall SW

TEPEE WALL SW

- Straight office panel

W••••	Width	400	800	1200			
Basic price (EUR)							
		708	833	964			
	Panel height						
PH2	1586 mm height	•					
	Integration						
IN-I	Module for integration – initial module	•	–	•	–	•	–
IN-M	Module for integration – middle module	+ 63	–	+ 63	–	+ 63	–
IN-E	Module for integration – end module	–	+ 123	–	+ 123	–	+ 123
IN-F	Freestanding module	–	+ 63	–	+ 63	–	+ 63
	Panel foot						
PF-N-③	Narrow panel foot	Powder-coated steel		•			
PF-W-③	Wide panel foot			+ 73	+ 146	+ 73	+ 146
	Panel finish						
DF-FC01/1.007	Grey felt	Natural beech		•			
DF-FC02/1.007	Light grey felt			○			
Sample order	TEPEE WALL SW (W400 PH2 IN-E PF-N-WH DF-FC01/1.007)						

③ – Please specify metal elements finish – see finishes

• Available as standard (included in basic price)

○ Available as an option (included in basic price)

Note: Connectors included in Tepee Office Wall assembly set.

Tepee office wall

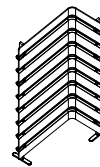
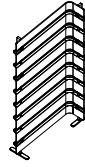

Tepee office wall CW90	Tepee office wall CW120
TEPEE WALL CW90	TEPEE WALL CW120
• Curved office panel 90°	• Curved office panel 120°

W•••	Width	800				800		
D•••	Depth	200	400		400			
		Basic price (EUR)						
		836	919		994			
		Panel height						
PH2	1586 mm height	•				•		
		Integration						
IN-I	Module for integration – initial module	•	–	•	–	•	–	
IN-M	Module for integration – middle module	+63	–	+63	–	+63	–	
IN-E	Module for integration – end module	–	+123	–	+123	–	+123	
IN-F	Freestanding module	–	+63	–	+63	–	+63	
		Panel foot						
PF-N-③	Narrow panel foot	Powder-coated steel	•				•	
PF-W-③	Wide panel foot		+73	+146	+73	+146	+73	+146
		Panel finish						
DF-FC01/1.007	Grey felt	Natural beech	•				•	
DF-FC02/1.007	Light grey felt		○				○	
Sample order	TEPEE WALL CW90 (W800 D200 PH2 IN-I PF-N-WH DF-FC01/1.007)							

③ – Please specify metal elements finish – see finishes

• Available as standard (included in basic price)

○ Available as an option (included in basic price)

Note: Connectors included in Tepee Office Wall assembly set.

Tepee cable management

Upholstered horizontal wire trunking

CABLE MANAGEMENT HC U

- Wire trunking, width 670 mm dedicated for Tepee Work SI, desk width 1200 mm

	Width		Basic price (EUR)
W670	For integration with desk width 1200 mm		188
	Finish		
⑤	Upholstery price group	4	•
Sample order	CABLE MANAGEMENT HC U (W670 CUZ09)		

⑤ – Please specify upholstery colour code from selected price group – [see finishes](#)

- Available as standard (included in basic price)

Tepee cable management

Upholstered vertical wire trunking







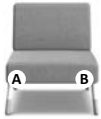

CABLE MANAGEMENT VC UPH 1

- Wire trunking, length 850 mm dedicated for Tepee Work sit SI

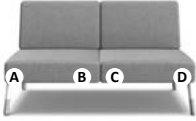
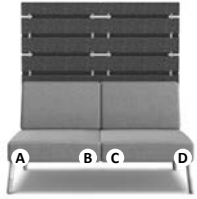

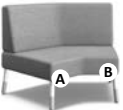

D••	Diameter (mm)	38	65
	Length	Basic price (EUR)	
L850	For integration with Tepee Work sit SI	66	75
	Finish		
⑤	Upholstery price group	4	•
	Assembly		
IN-T	Fixing directly to table top	•	
Sample order	CABLE MANAGEMENT VC UPH 1 (DI38 L850 CUZ09 IN-T)		

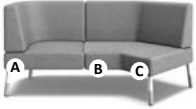
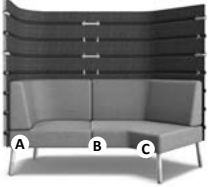
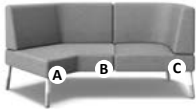
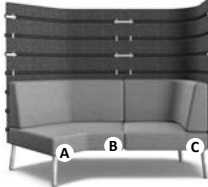
Tepee Sofa

MEDIA PORTS CONFIGURATION TABLE

Product model version	MEDIA PORT LOCATION	
	—	1586 mm
S1 S1 P Max one media port in location A or B		
S2 S2 P Max two media ports in location A, B, C or D		
C90 right version C90 P right version One media port available in location A		
C90 left version C90 P left version One media port available in location A		
C 135 C135 P Max one media port in location A or B		
C135 + 90 right version C135 + 90 P right version Max two media ports in location A, B or C		
C135 + 90 left version C135 + 90 P left version Max two media ports in location A, B or C		

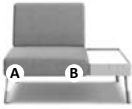
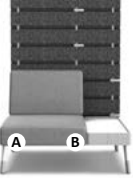
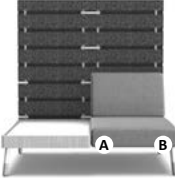
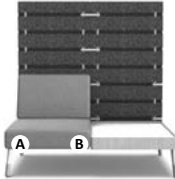
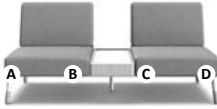
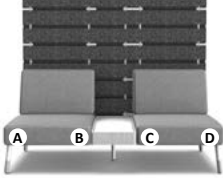
MEDIA PORTS CONFIGURATION TABLE

Product model version	MEDIA PORT LOCATION	
	—	1586 mm
FS2 FS2 P Max two media ports in location A or B		
STS right version STS P right version Max one media port in location A or B		
STS left version STS P left version Max one media port in location A or B		
STB right version STB P right version Max one media port in location A or B		
STB left version STB P left version Max one media port in location A or B		
STC STC P Max two media ports in location A, B, C or D		
FS1 Max one media port in location A or B		

Technical description

Modular line of Tepee sofas and office walls enables to create arrangements that suit office areas of different functionalities. The system is perfect for arranging informal meeting places and relaxation zones as well as reception areas.

Tepee

The line consists of several sofa models that can be arranged freely. Free standing armchair without felt panel (FS1) is the only exception with no extension possibility. Some models are available with a table as an option. The table is fully integrated with the seat and based on the same structure which allows for reducing the number of legs. Tables also available as freestanding modules. Tepee sofas except FS1 model can be equipped with a felt panel available in three heights: 1586 mm which provides possibility of creating „room-in-room” arrangements.

As an option, individual sofa models and tables can be equipped with electric ports: **Bachmann PIX** – electric port dedicated to Tepee sofas available in 2 configurations: 1 x 230V or 2xUSB, cable length 3 m, plastic in black colour only.

PIX 1–230V PIX 2–2xUSB

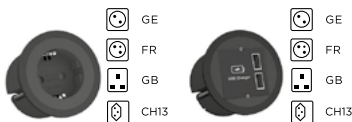

OE Electrics Pluto – electric port dedicated to Tepee tables available in two configurations: 3 x 230V or 2 x 230V + 2xUSB, in standard: CH13, FR, GB, GE, cable length 1,5 m, plastic in white colour only.



Maximum number of media ports and location available in configuration table. Socket type to be specified in the order.

Tepee line is complemented with:

- Tepee Wall
- Tepee Wall TV
- Tepee Work

Sofa construction

Sofas without panel

The structure of sofas is made of metal and wooden frame. Metal frame made of profiles and round tubes as part of legs, powder-coated in Jet Black (BL), Traffic White (WT) or Cashmere (NK) colours. Wooden solid beech part of legs finished in natural (1.007), black (2.07Y) or white stain (2.09S). Seat structure made of three-layer cut foam density 40 kg/m³, thickness 95–130 mm. Backrest made of cut foam density 21 kg/m³, thickness 95 mm.

Sofas with panel

The structure of sofas is made of metal and wooden frame. Metal frame made of profiles and

round tubes as part of legs powder-coated in Jet Black (BL), Traffic White (WT) or Cashmere (NK) colours. Wooden solid beech part of legs finished in natural (1.007), black (2.07Y) or white stain (2.09S). Seat structure made of three layer cut foam density 40 kg/m³, thickness 95–130 mm. Backrest made of cut foam density 21 kg/m³, thickness 95 mm.

Sofas are integrated with thermoformed felt panel (100% polyester fiber with reduced fusibility subjected to a needling process) available in 3 heights: 1586 mm and in two colours: dark grey (FC01) and light grey (FC02). The felt panel is fixed to sofa backrest with plywood profiles and additionally stabilized with solid beech wood connectors. Proper number of linking connectors to be ordered separately when sofa to sofa with panel connection is required. Please see section 7 and price list to calculate proper number of connectors.

Freestanding tables

Freestanding table is available with both sides HPL laminated table top and solid beech wooden frame. Metal frame made of profiles and round tubes as part of legs powder-coated in Jet Black (BL), Traffic White (WT) or Cashmere (NK) colours. Wooden solid beech part of legs finished in natural (1.007), black (2.07Y) or white (2.09S).

Tepee Wall

Tepee Walls are made of thermoformed felt (100% polyester fiber with reduced fusibility subjected to a needling process) with plywood profiles which stabilize the wall and the foot for each profile. Tepee Walls available as straight (SW), curved 90° (CW 90) or 120° (CW 120) versions for integration or freestanding. Tepee Walls available in 3 heights: 1586 mm and in two colours: dark grey (FC01) and light grey (FC02). Felt panels may differ in shade in colour. Tepee Walls available as versions for integration or freestanding.

Tepee Wall for integration

Initial module – this module starts the arrangement for integration. External linking connectors included in the structure of initial module.

Middle module – this module to be connected on both sides with initial module, another middle or end module. Internal linking connectors included in the structure of middle module.

End module – this module always ends the arrangement to be connected with initial or middle module. Internal and external linking connectors included in this module.

Tepee Wall dedicated for integration cannot be a freestanding wall. To connect the walls for integration, internal linking connectors required. Each arrangement ends with external linking connectors. Both internal and external connectors are made of solid beech wood. Initial, end module and any number of middle modules enable to create the arrangement with adequate number of connectors and feet, narrow as standard, wide as an option. Connectors and feet included in the structure of Tepee Walls.

Tepee Wall freestanding module – equipped with proper number of external connectors made of solid beech wood and feet, Feet narrow as standard or wide as an option.

Feet options for Tepee Walls:

Narrow foot – made of metal powder-coated in Jet Black (BL), Traffic White (WT) or Cashmere (NK) colours.



Wide foot – made of metal powder-coated in Jet Black (BL), Traffic White (WT) or Cashmere (NK) colours, equipped with Velcro type fixing for soft floors or skidproof rubber for hard floors (both as standard) to increase stability of arrangement.

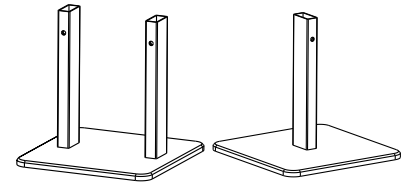

Foot dedicated to connect two Tepee Walls

Foot dedicated to external walls or freestanding walls

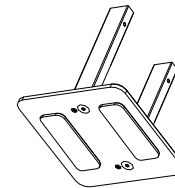

Velcro type fixing for soft floors or skidproof rubber for hard floors

Tepee Walls, both freestanding and for integration are equipped with proper number of internal and external connectors as standard and narrow feet as standard or wide feet as an option.

Tepee Walls with dedicated connectors and feet:

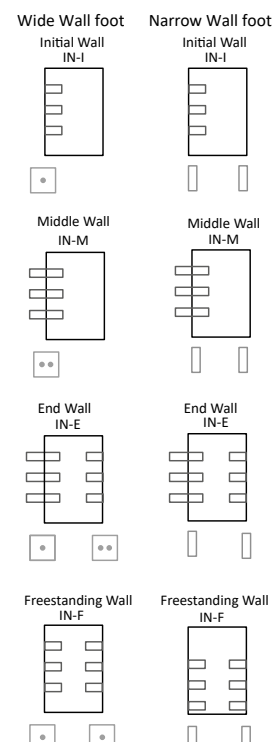

Technical description

Freestanding Tepee Wall SW with narrow and wide feet:

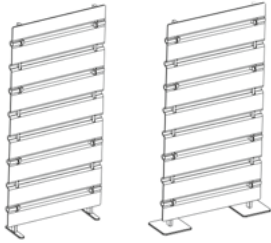

Narrow IN-F Wide IN-F

Tepee Wall TV

Tepee Wall TV dedicated for integration with two FS2 sofas with panels, height 1586 mm only. The Wall 80 × 1586 mm is made of thermoformed felt (100% polyester fiber with reduced fusibility subjected to a needling process) with integrated table. Table top is made of melamine faced chipboard MFC, thickness 25 mm and metal leg powder-coated in Jet Black (BL), Traffic White (WT) or Cashmere (NK) colours. Media ports or grommets available as an option. Two versions available: without TV holder as standard or with TV set (fixed tilting holder Athletic) as an option. TV monitor size is max 32".

Tepee Wall TV with FS2 sofas sample arrangement:

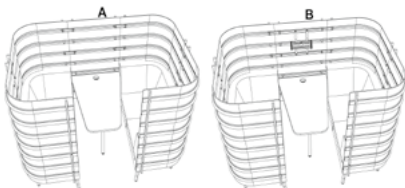

Fixed TV holder for B version.

Tepee Work

Tepee Work workstations dedicated for temporary work consist of Tepee Walls integrated with table top.

Two versions available:

Tepee Work SIT – panel height 1586 mm as standard, table top made of melamine faced chipboard MFC, thickness 25 mm, height 780 mm, width 1200 mm. Further connection with Tepee Wall and sofas with integrated panels available as an option. Grommets, media ports and cable management for table top available as an option.

Tepee Work SIT for integration

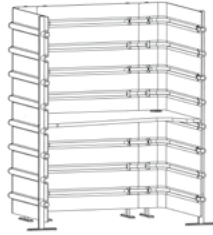

Tepee Work media port:

OE Electrics Pixel – electric port dedicated to Tepee Work table top available in configuration of 1 × 230V + 2XUSB, cable length 3 m, plastic in black colour only.

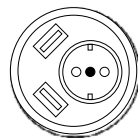

- GE
- FR
- GB
- CH13

Feet options for Tepee Work:

- narrow foot made of metal powder-coated in Jet Black (BL), Traffic White (WT) or Cashmere (NK) colours as standard,
- wide foot made of metal powder-coated in Jet Black (BL), Traffic White (WT) or Cashmere (NK) colours as an option dedicated to external profiles to increase stability of initial walls of the arrangement, additionally equipped with Velcro type fixing for soft floors or skidproof rubber for hard floors (both as standard).

Connectors

Sofa connector – made of metal to connect sofa models with each other. The connectors are not visible when assembled to the frame under the seat.

The number of internal connectors needed for assembly of Tepee sofas:

$$2 \times (n - 1 - k)$$

n – the number of modules in a specific arrangement,

k – the sum of C90D modules in a specific arrangement.

Note: Number of connectors to be specified for each separate arrangement.



Panel connector – made of solid beech wood lacquered to connect panels made of thermoformed felt which stabilizes the panel additionally strengthened with beech plywood profile. The connectors are fixed to the panel with screws included in assembly set.

Types of connectors:

External connector – dedicated to end panels of the arrangements.

The number of connectors needed for assembly:
– for sofas with panel height 1586 – 4 pcs.



Internal connector – dedicated to connect panel to panel.

The number of connectors needed for assembly:
– for connecting 2 sofas with panel height 1586 mm – 2 pcs.



The number of internal connectors needed for assembly Tepee sofas with panel:
 $2 \times (n - 1)$ for sofas with panel height 1586, n – the number of sofas panels in a specific arrangement.

Note: Number of connectors to be specified for each separate arrangement.

Connectors for freestanding sofas with panels and Tepee Walls included in assembly set.

Wire trunking

Horizontal wire trunking – dedicated to Tepee Work made of upholstery fixed directly to table top with plastic brackets. Two widths available: 1200 mm, height 120 mm.

Vertical wire trunking – dedicated to Tepee Work Sit – length 850 mm. It is made of upholstery with zip fixed directly to table top with plastic brackets.

Tepee Work SIT for integration – sample arrangements:

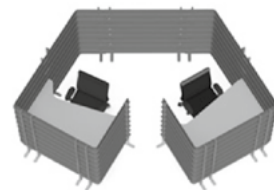

Technical description

Configuration rules

Connection of modules of the same panel height only. Sofa module with table and panel to be integrated with another sofa with panel only.

Tepee sofas with panel configuration



Correct

Tepee Walls configuration

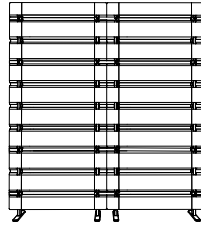

Correct

Tepee sofa module with table and panel to be integrated with another sofa with panel

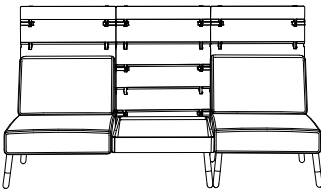

Correct

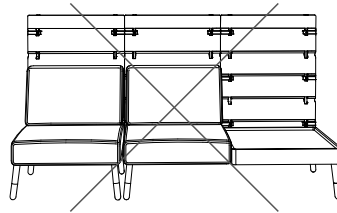





Incorrect



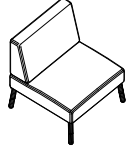
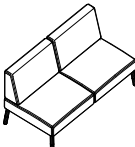

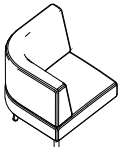
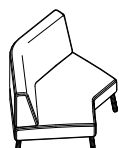
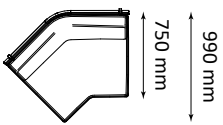
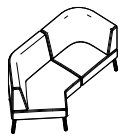
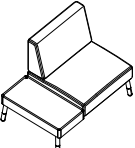

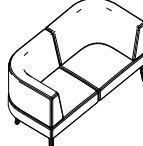
Technical regulations, approvals and quality marks for the chairs (for selected product configurations)

Certificate compliant with norms:
EN 16139; EN 15372; EN 1023-2

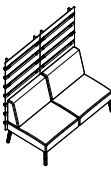
Dimensions

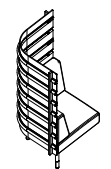
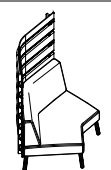
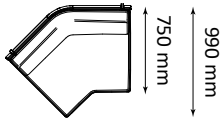

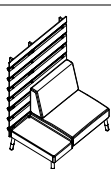
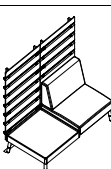
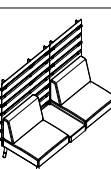

Model	Drawing	Seat height	Backrest height	Total height	Total width	Total depth	Table top height
FS1		420 mm	420 mm	840 mm	1026 mm	734 mm	
S1		420 mm	420 mm	840 mm	750 mm	750 mm	
S2		420 mm	420 mm	840 mm	1500 mm	750 mm	
C90 right and left version		420 mm	420 mm	840 mm	750 mm	750 mm	
C90D right and left version		420 mm	420 mm	840 mm	750 mm	750 mm	
C 135		420 mm	420 mm	840 mm	1110 mm		
C135 + 90 right and left version		420 mm	420 mm	840 mm	1860 mm	750 mm	
STS right and left version		420 mm	420 mm	840 mm	1125 mm	750 mm	350 mm
STB right and left version		420 mm	420 mm	840 mm	1500 mm	750 mm	350 mm
STC		420 mm	420 mm	840 mm	1875 mm	750 mm	350 mm
FS2		420 mm	420 mm	840 mm	1500 mm	750 mm	

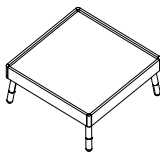
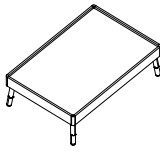
Dimensions

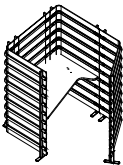
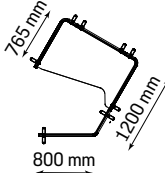
Model	Drawing	Seat height	Backrest height	Total height with panel	Total width	Total depth	Table top height
S1 with panel		420 mm	420 mm	1586 mm	750 mm	750 mm	
S2 with panel		420 mm	420 mm	1586 mm	1500 mm	750 mm	
C90 with panel right and left version		420 mm	420 mm	1586 mm	750 mm	750 mm	
C90D with panel right and left version		420 mm	420 mm	1586 mm	750 mm	750 mm	
C135 with panel		420 mm	420 mm	1586 mm	1110 mm		
C135 + 90 with panel right and left version		420 mm	420 mm	1586 mm	1860 mm	750 mm	
STS with panel right and left version		420 mm	420 mm	1586 mm	1125 mm	750 mm	350 mm
STB with panel right and left version		420 mm	420 mm	1586 mm	1500 mm	750 mm	350 mm
STC with panel		420 mm	420 mm	1586 mm	1875 mm	750 mm	350 mm
FS2 with panel		420 mm	420 mm	1586 mm	1500 mm	750 mm	

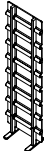
Tables				
Model	Drawing	Total height	Total width	Total depth
Tepee table 750 x 750		350 mm	750 mm	750 mm
Tepee table 1125 x 750		350 mm	1125 mm	750 mm

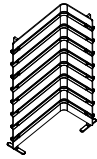
Work						
Model	Drawing	Total height	Total width	Table top width	Working surface height	Wing
Tepee Work Sit		1586 mm	1200 mm	800 mm	780 mm	

Office Panels				
Model	Drawing	Total height	Total width	Total depth
Tepee Office Wall SW		1586 mm	400/ 800/ 1200 mm	—
Tepee Office Wall SW CW90	 	1586 mm	800 mm	200/ 400 mm
Tepee Office Wall CW120		1586 mm	800 mm	400 mm